

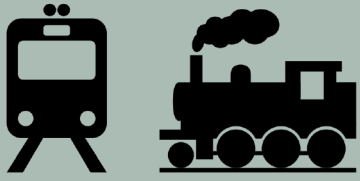

MILS Hinge Track Single Track



Reference Instructions Sheet

205

Rev
A

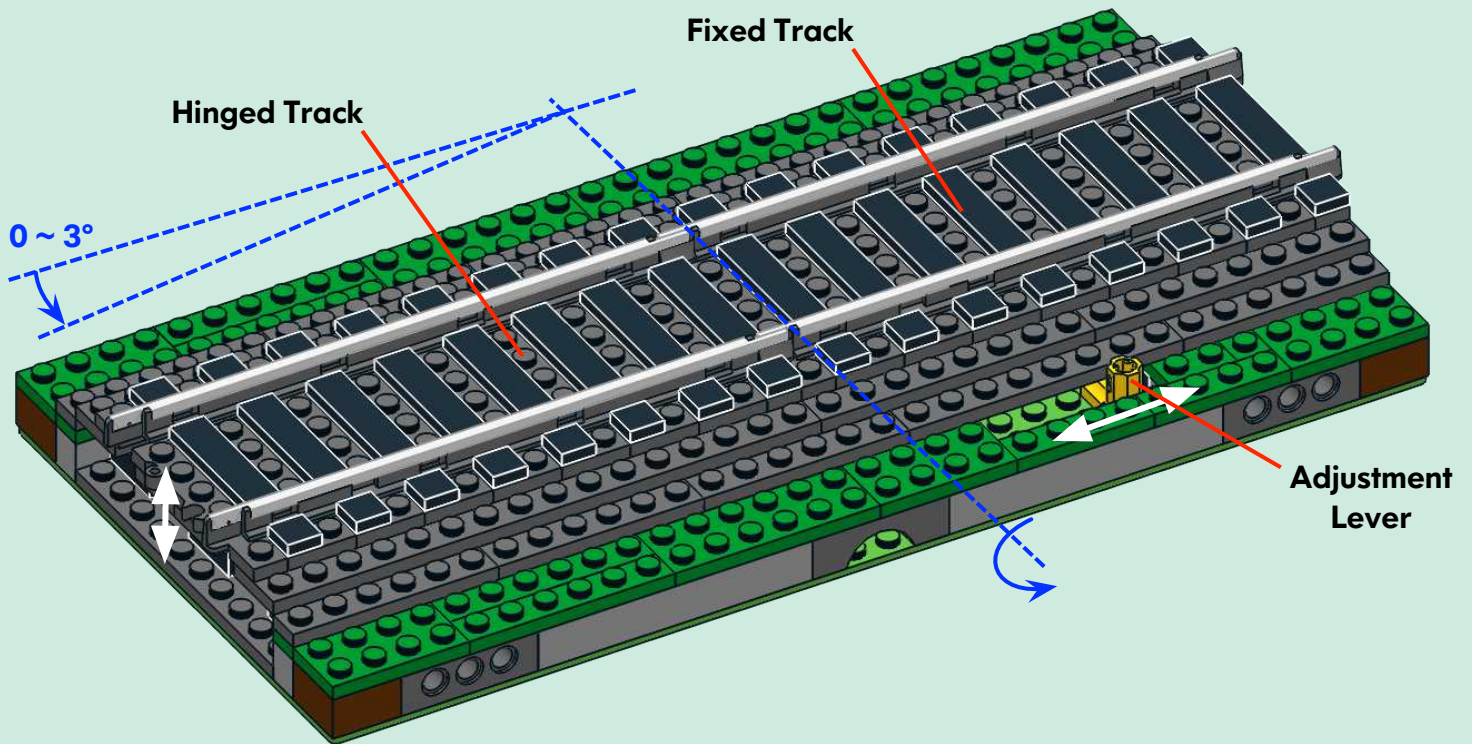

220 pcs

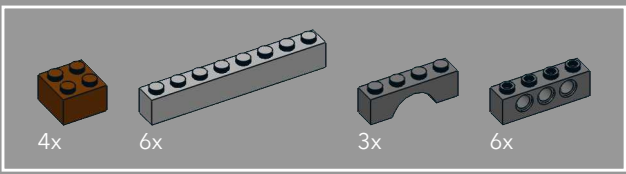

1

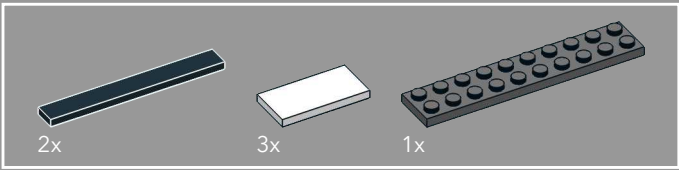
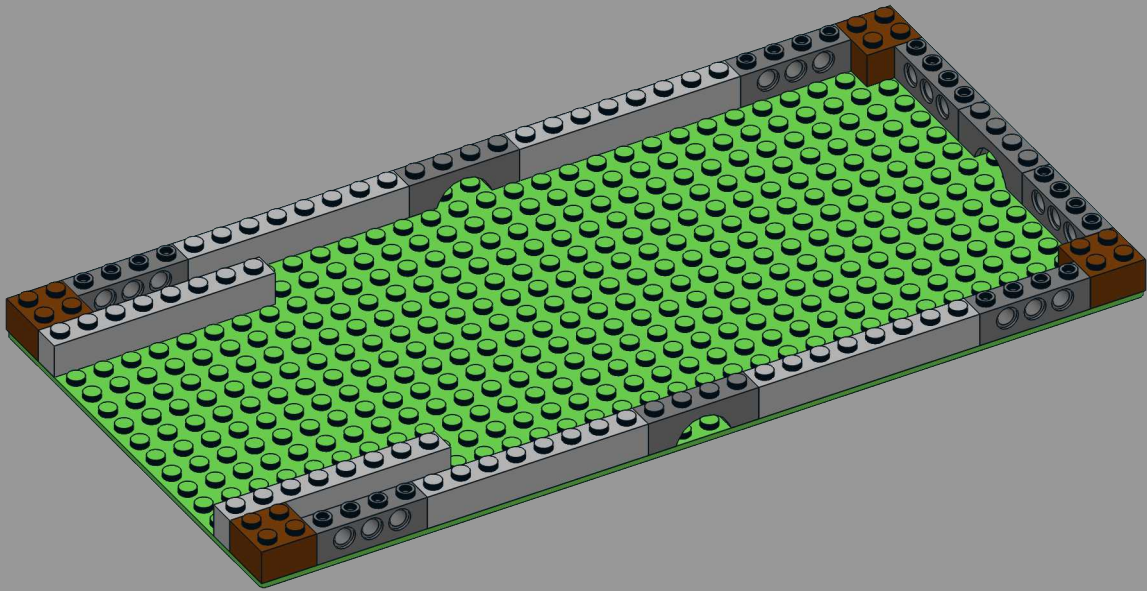

2

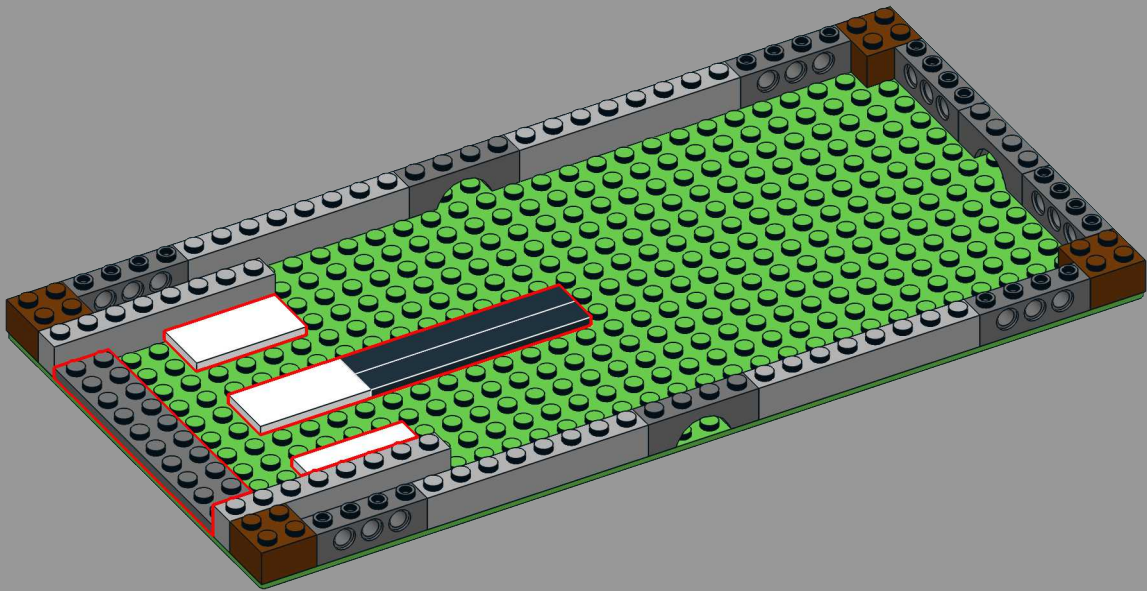

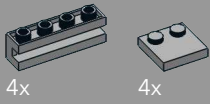

4x

4x

3

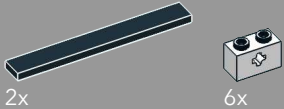
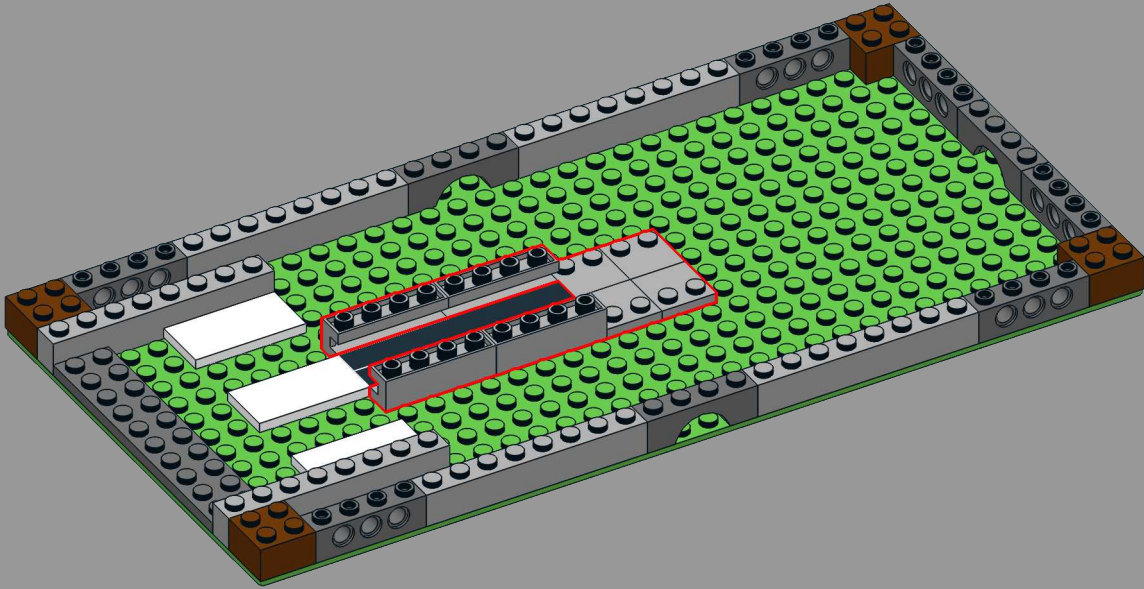

2x

6x

4

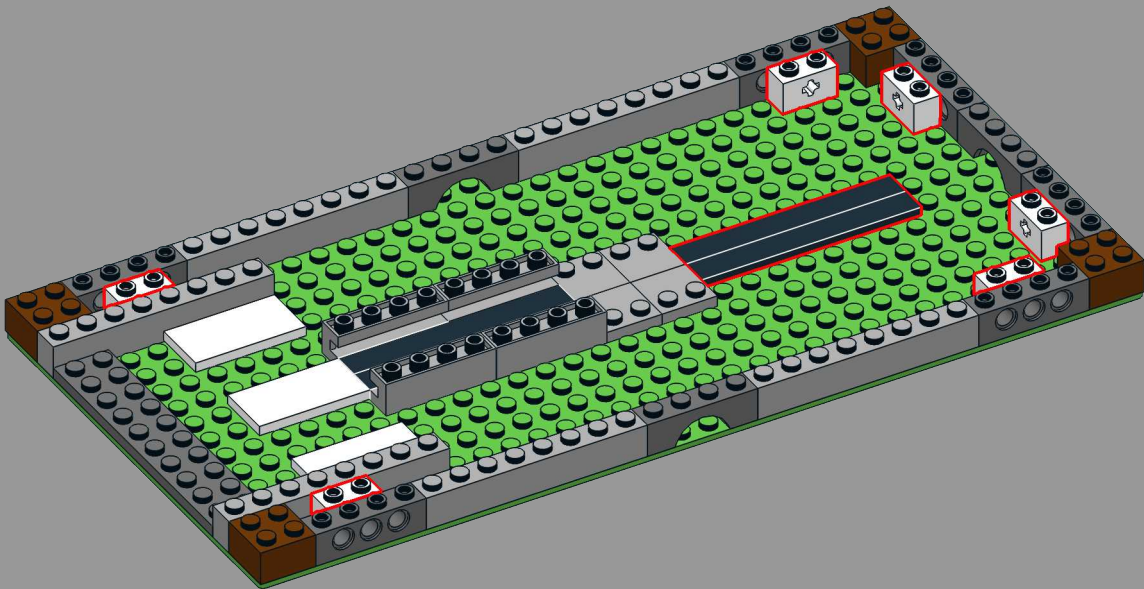

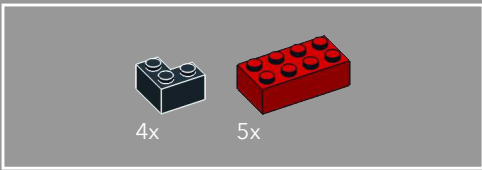

5

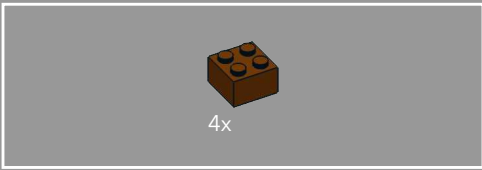
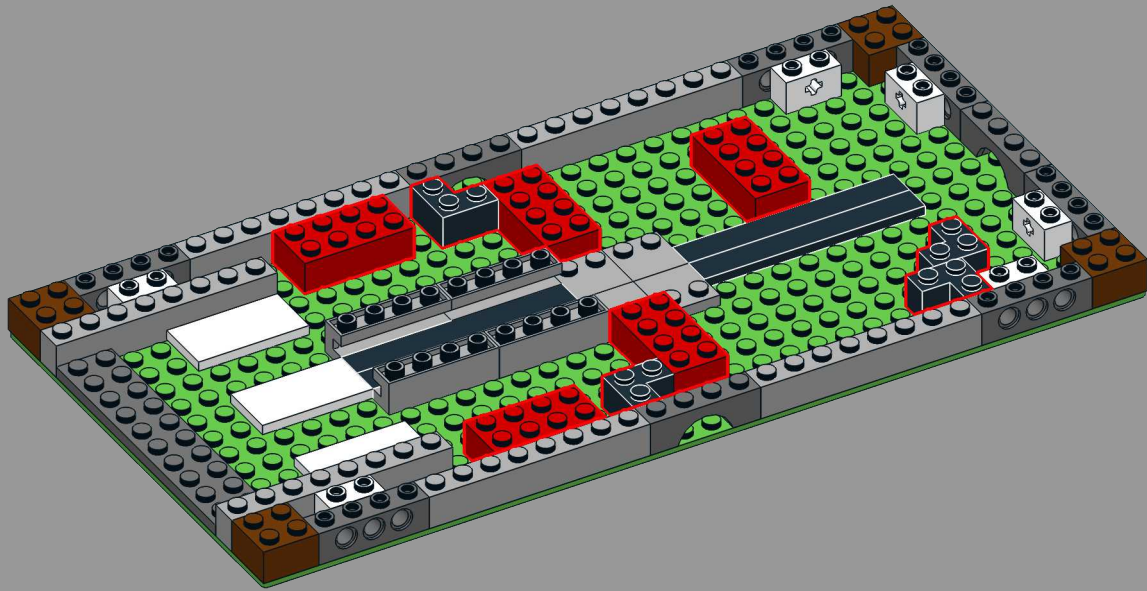

6

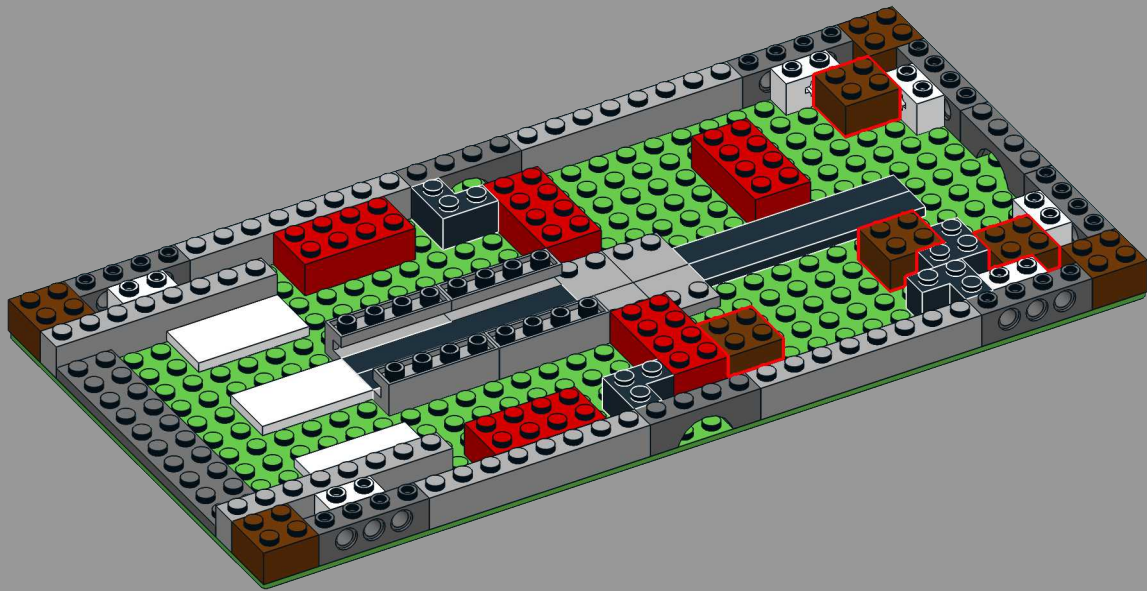

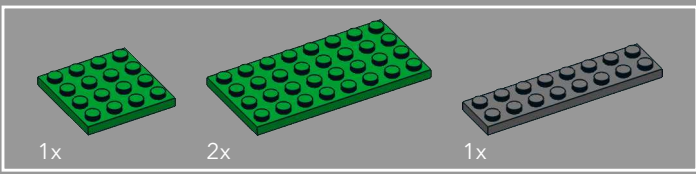

7

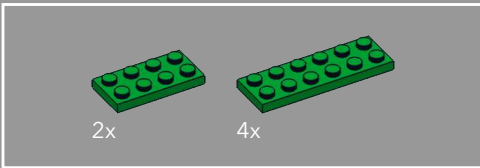
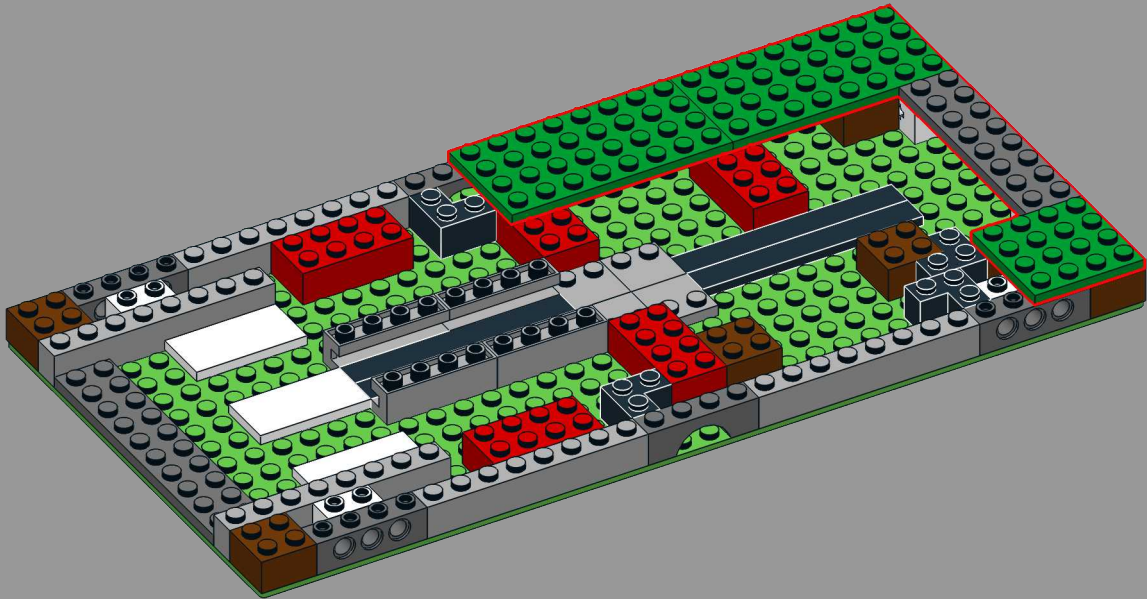

8

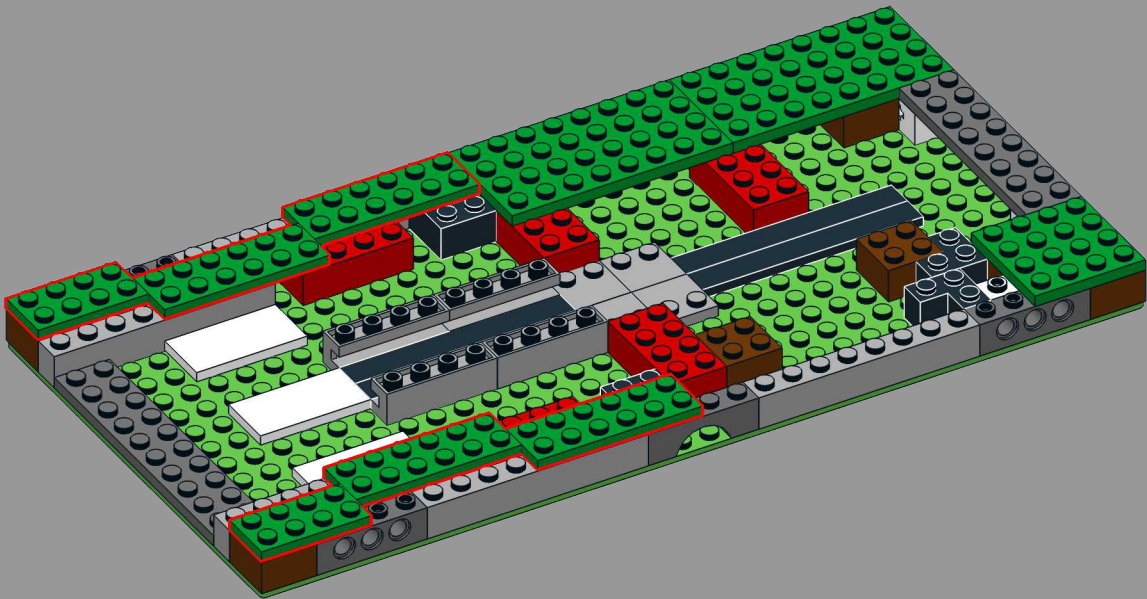

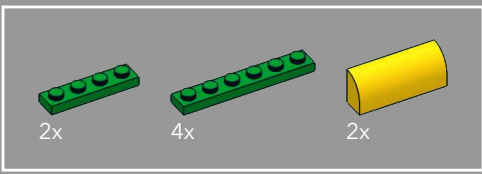

9

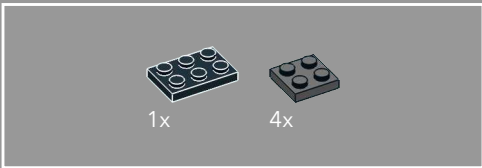
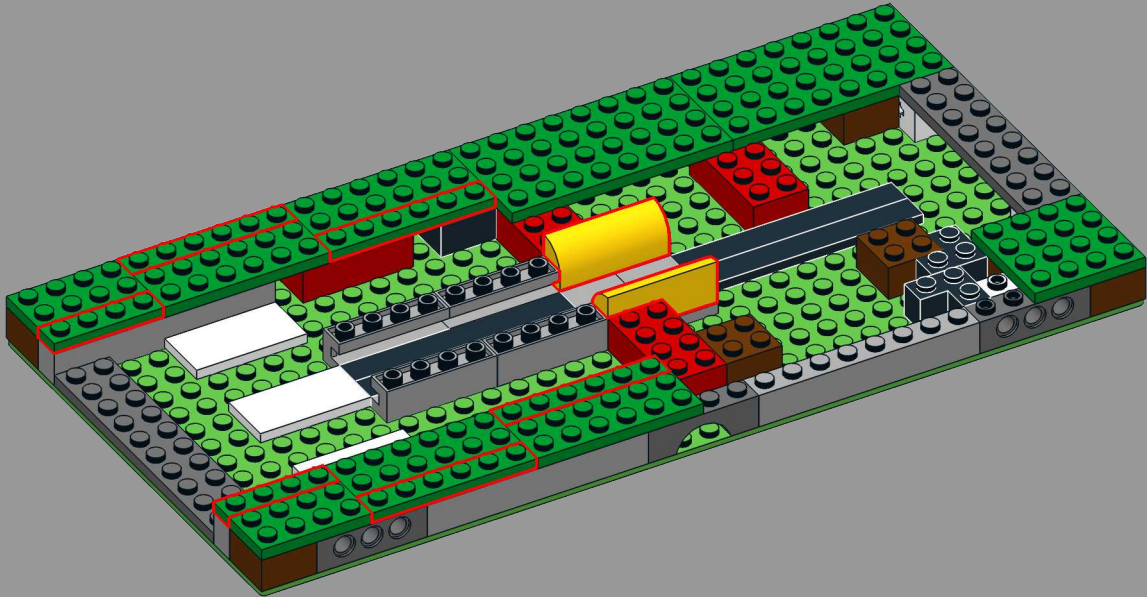

10

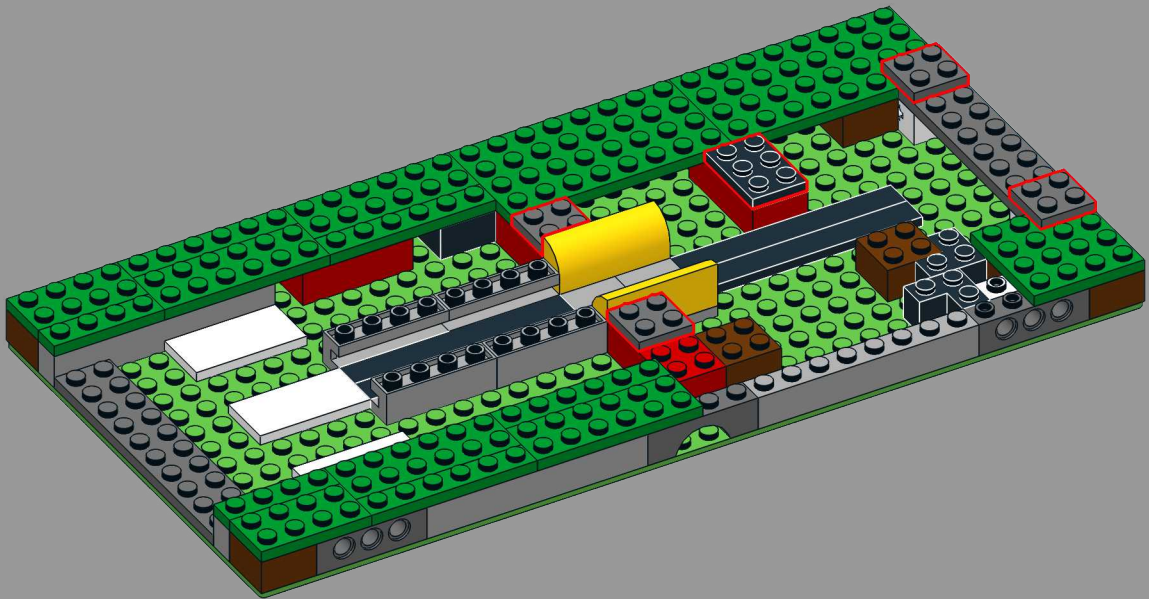

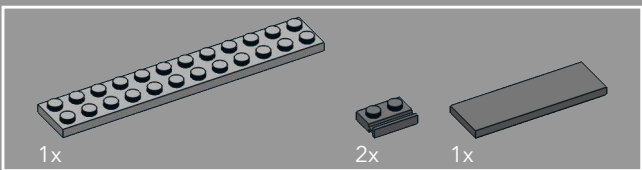
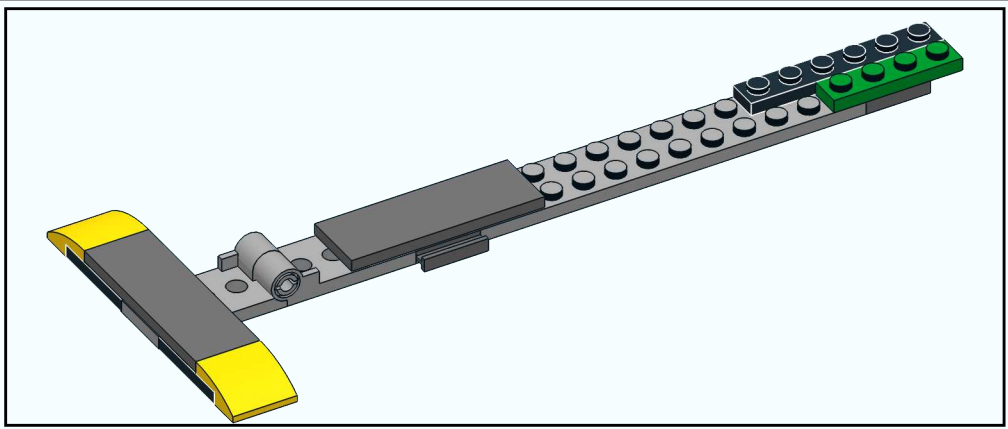

11

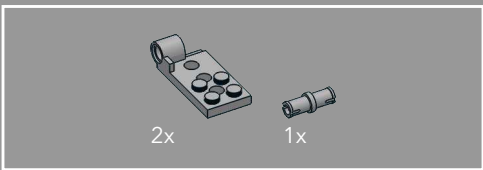
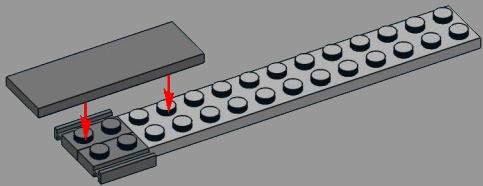

12

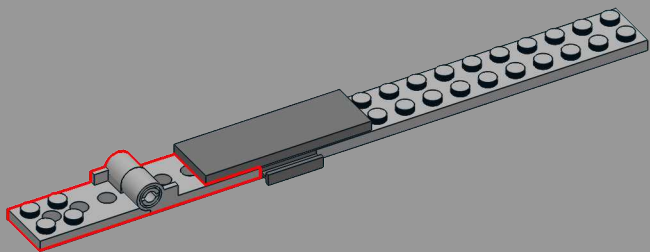

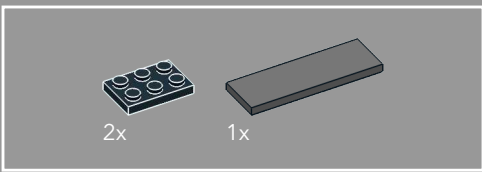

13

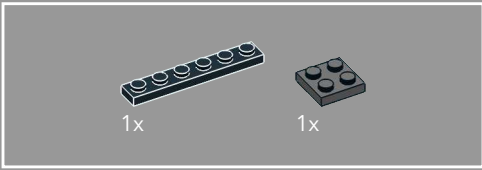
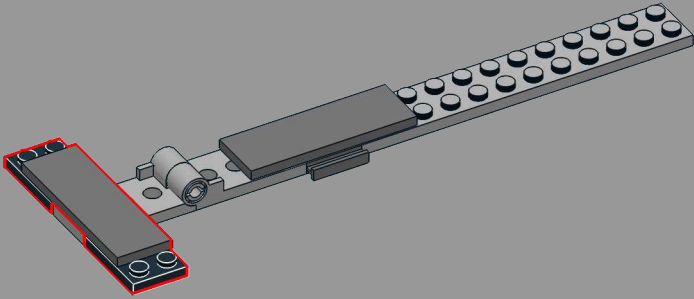

14

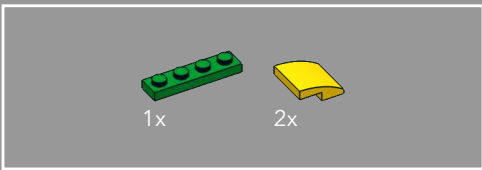
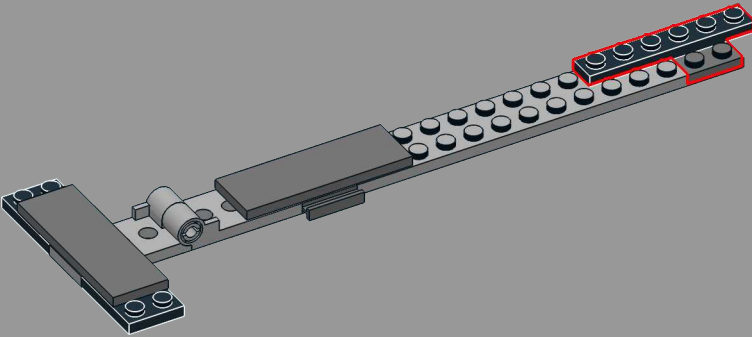

15

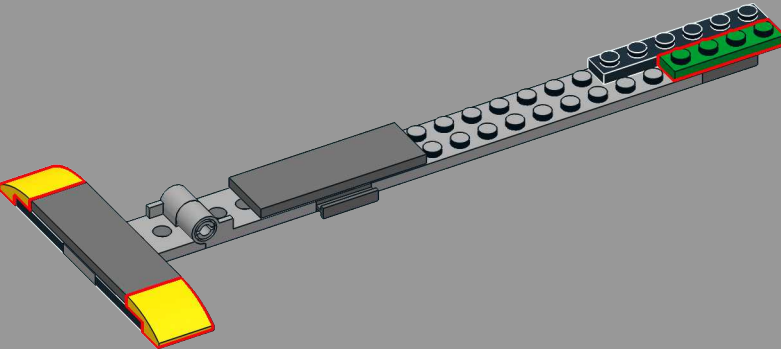

16

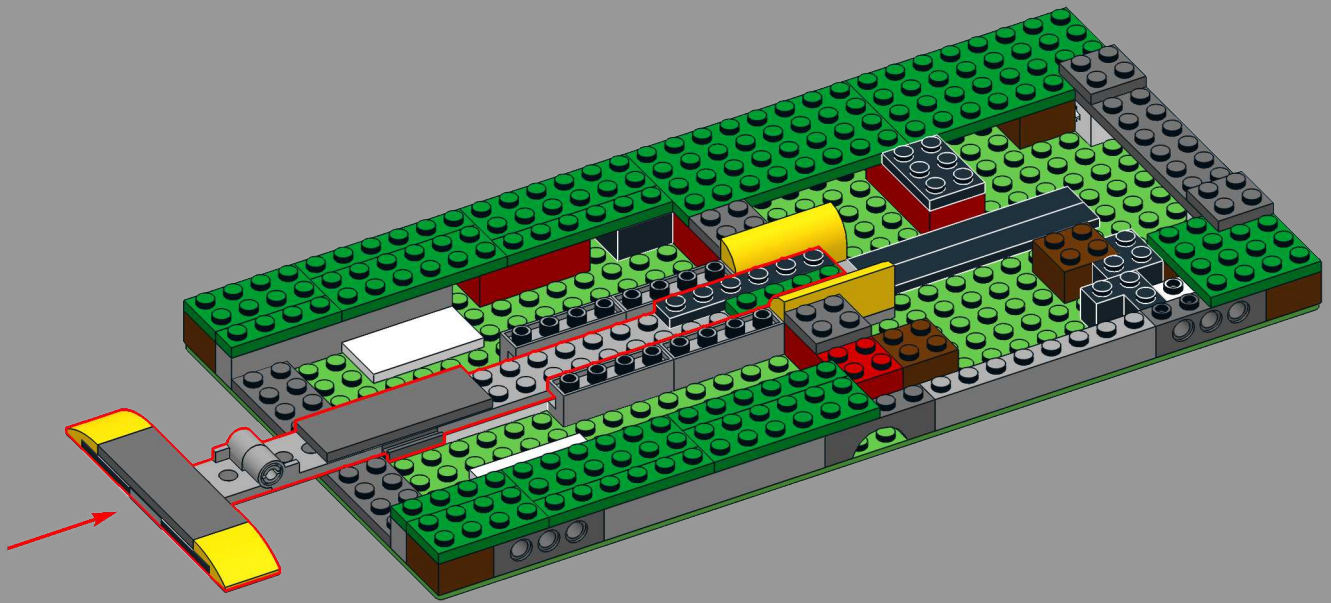

3x

17

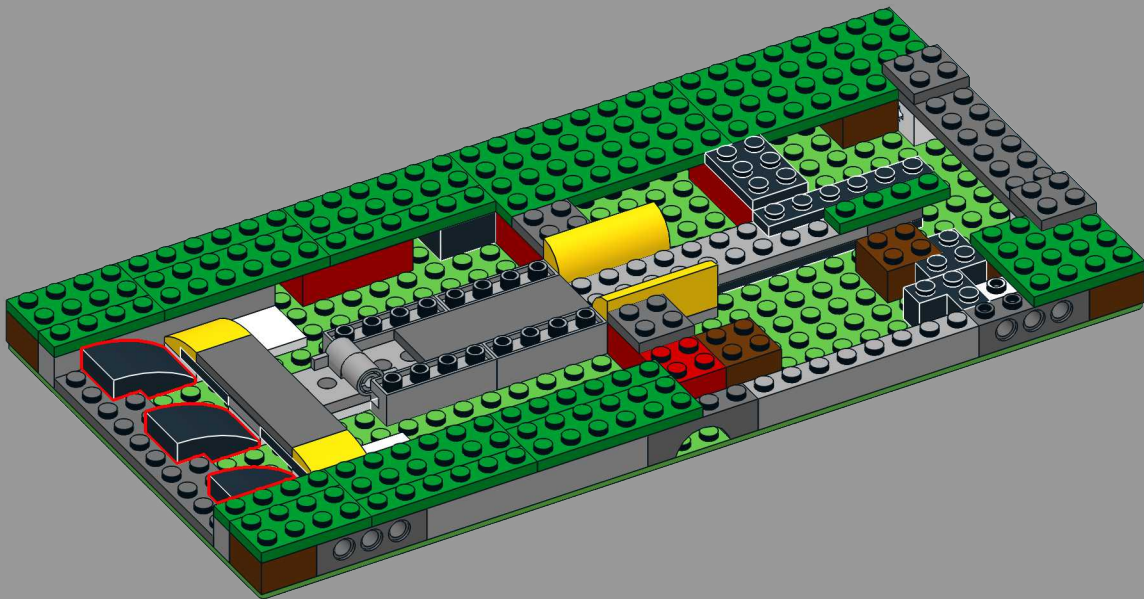



18

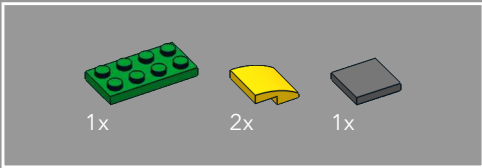
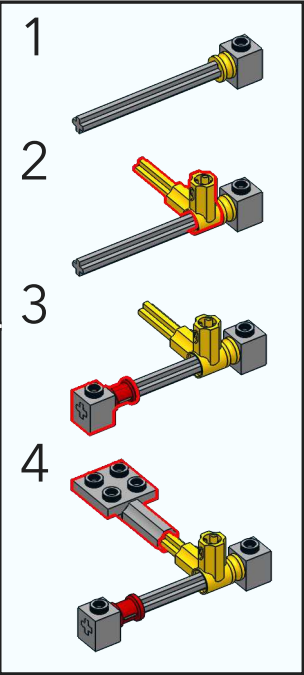
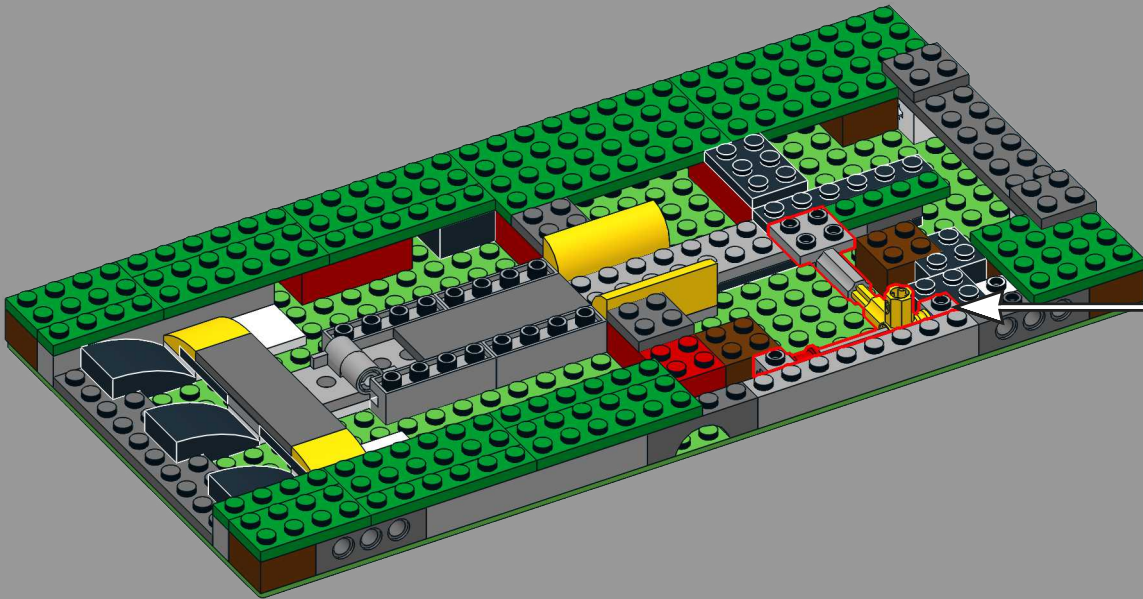

19

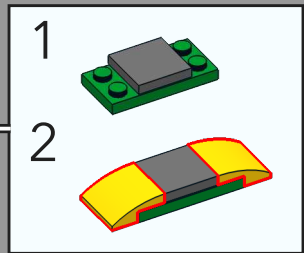
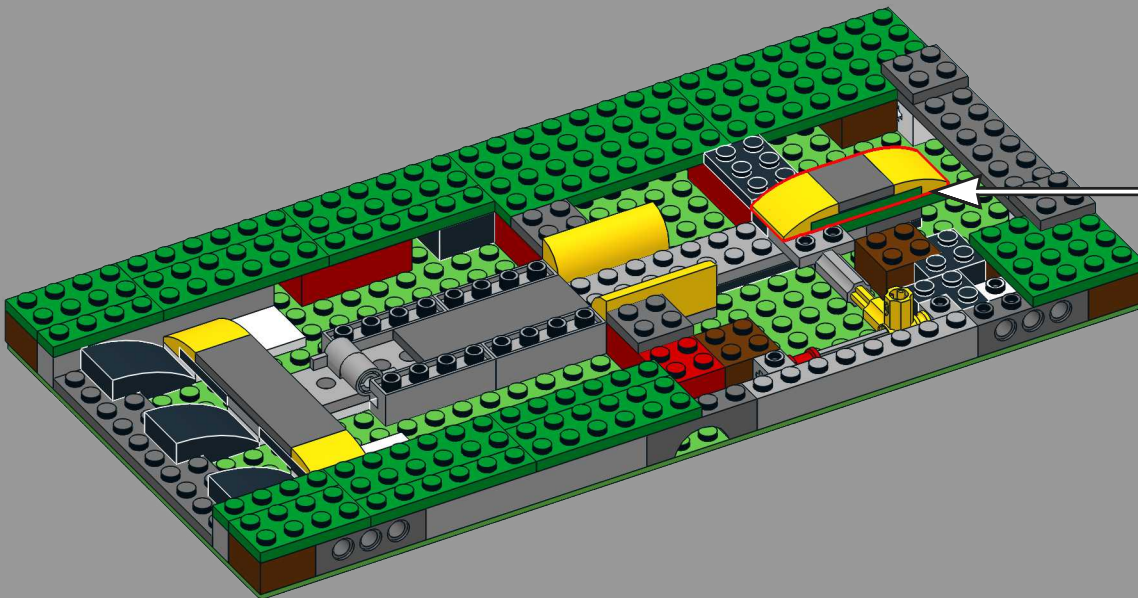

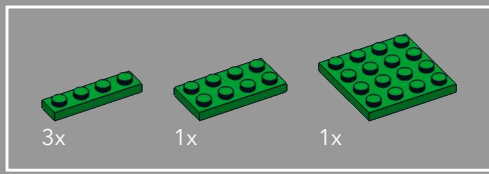

20

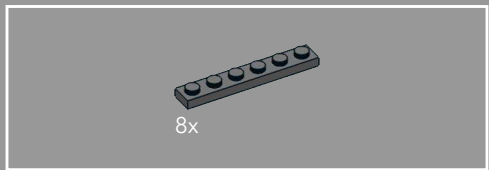
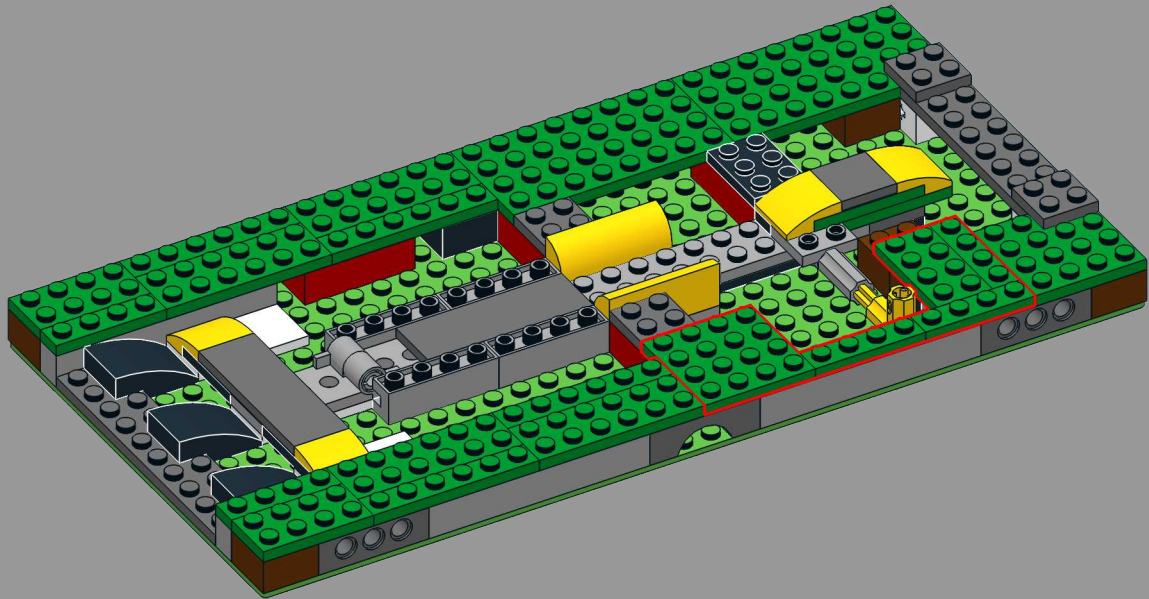

21

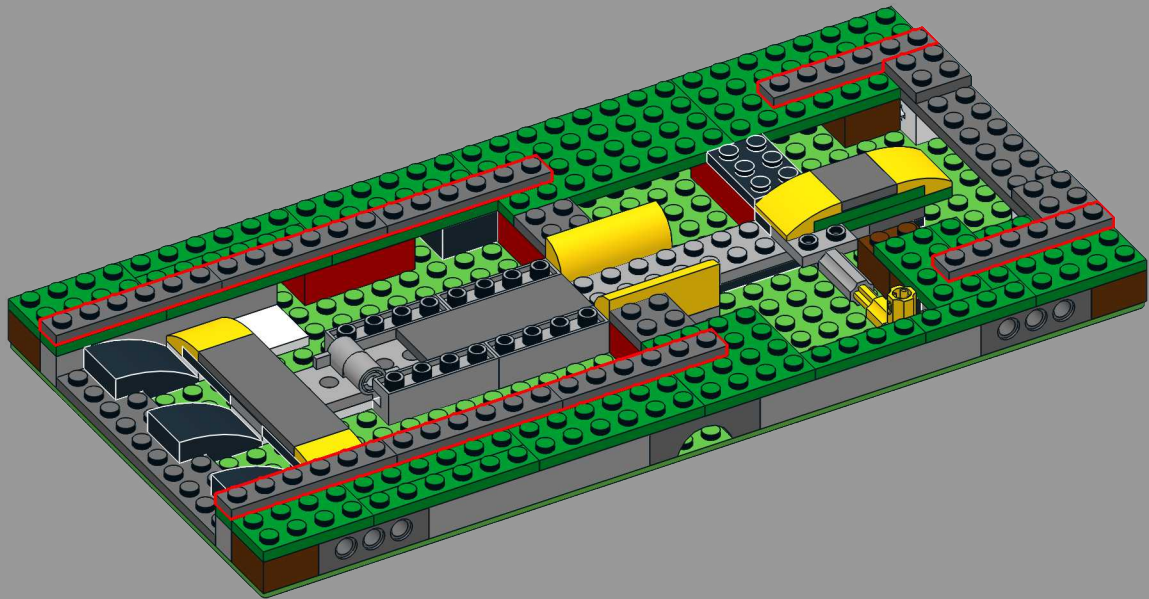

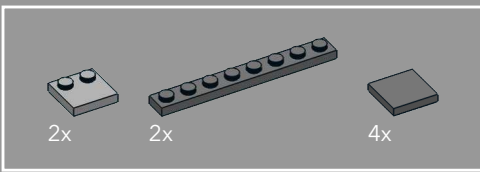

22

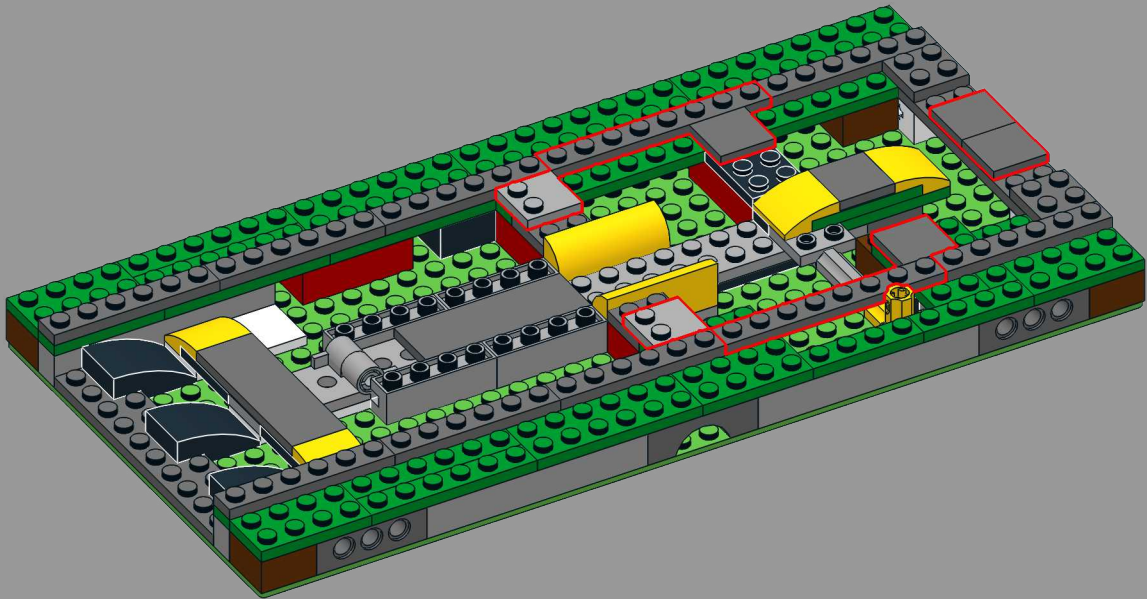

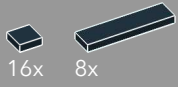

16x

8x

25

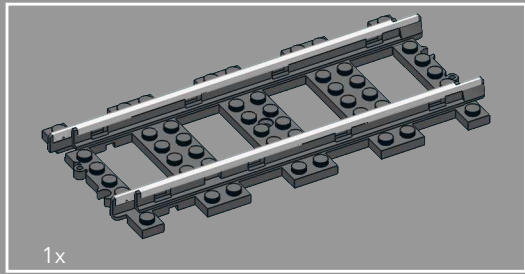
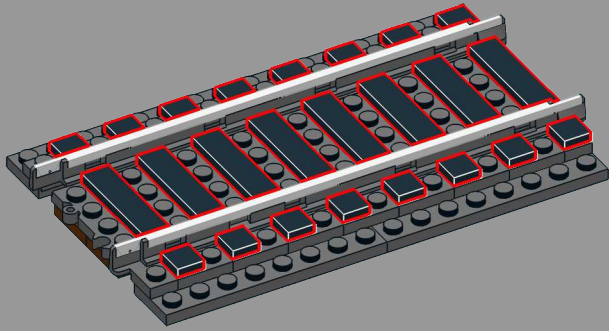

1x

26

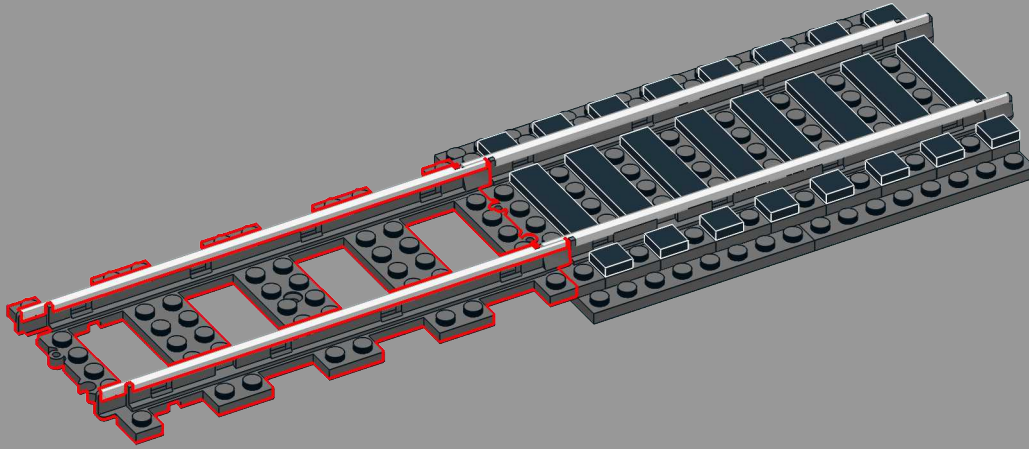

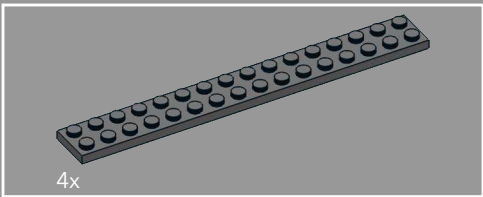

27

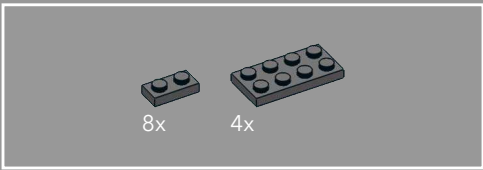
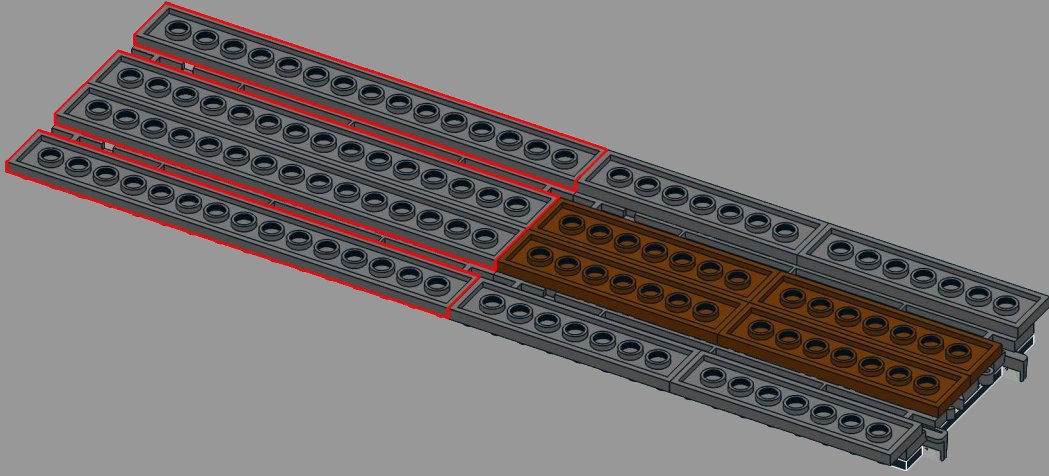

28

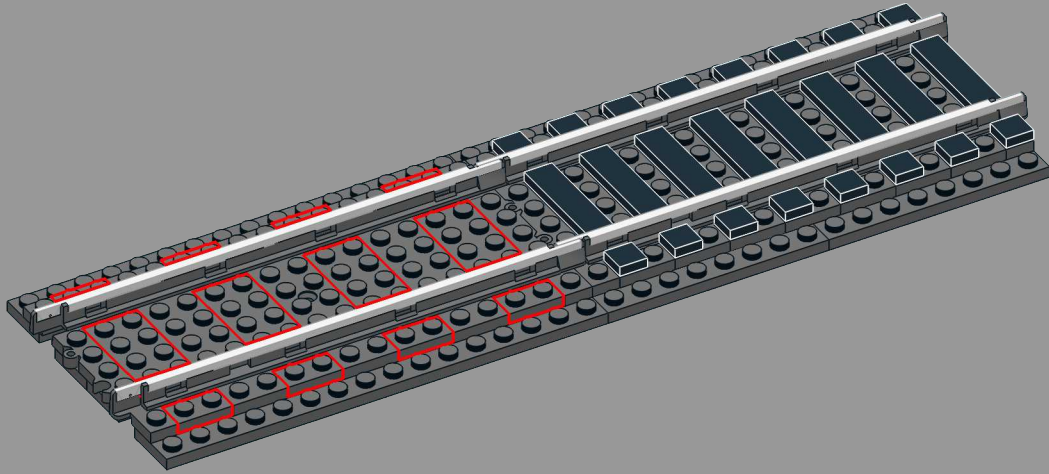

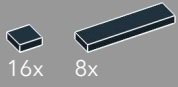

16x

8x

29

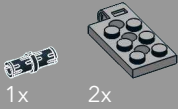
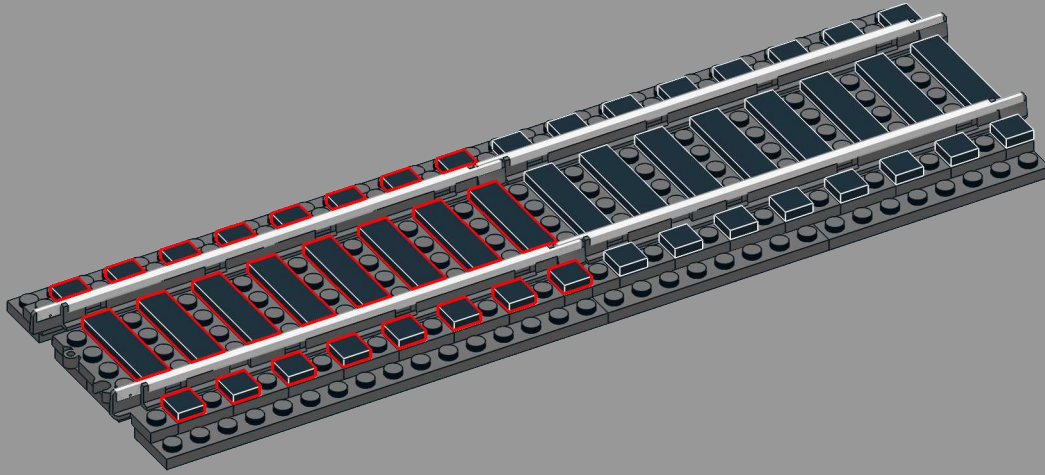

1x

2x

30

